

DETAIL B  
SCALE 2 : 5

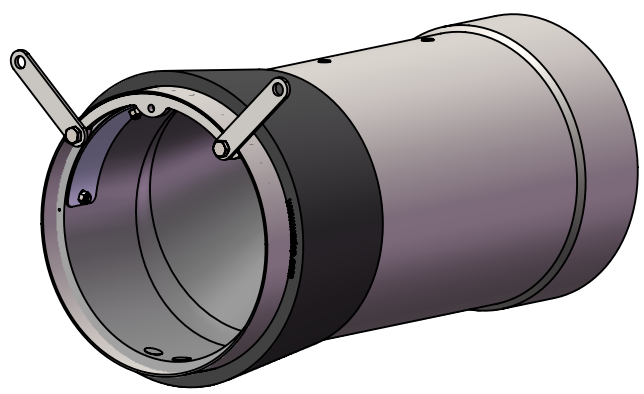
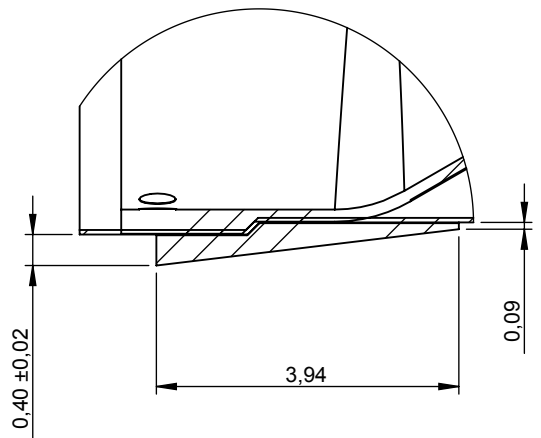

© 2017 Wapro AB. This document is subject to copyrights owned by Wapro AB. Any amendments, republication, retransmission, and/or reproduction of all or any part of the document is expressly prohibited, unless the copyright owner of the material has expressly granted its prior written consent. All other rights are reserved.

Designed By RB	Approved By RB	Created Date 2017-09-19	Units [inch]	General Tolerance SS-ISO 2768-1 m	Scale 1:5	
Material AISI 304 / AISI 316			Comments		Project Number	
Weight [Lbs] 8.5		Box Volume [ft³] 0.06	Description WaStop NPS 8"			
 www.wapro.com			Article Number WS193-S		Rev 2017-09-12	Sheet 1 (1)