

WaBack[®] Check Valve Technical Specification**Model no.** WB110-600**Nominal Size:****Material**

Manhole: PE

Float: PE

Bracket: Stainless steel (AISI 304)

Rubber joint: EPDM

Plate: PVC

Fasteners: Stainless steel (AISI 316)

Foam seal: PE-foam

Damper: EPDM/304

Technical data:	
Closing head*	3,9"
Manhole size	24"
Riser	24"

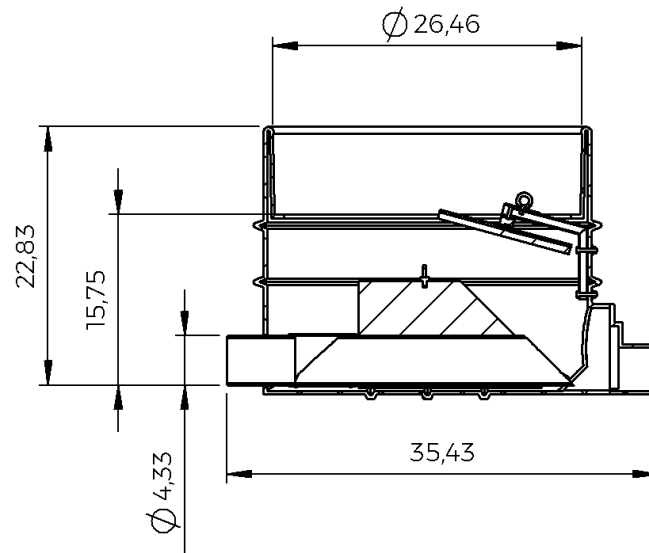

*) +/- 15%

- Values measured from bottom of pipe.

- Tests performed at room temperature (61-68°F). No pipe connected downstream