

WaBack[®] Check Valve Technical Specification

Model no.	WB160-600
Nominal Size:	160 mm
Material	
Manhole:	PE
Float:	PE
Bracket:	Stainless steel (AISI 304)
Rubber joint:	EPDM
Plate:	PVC
Fasteners:	Stainless steel (AISI 316)
Foam seal:	PE-foam
Damper:	EPDM/304

Technical data:	
Closing head*	145 mm
Manhole size	600 mm
Riser	600 mm

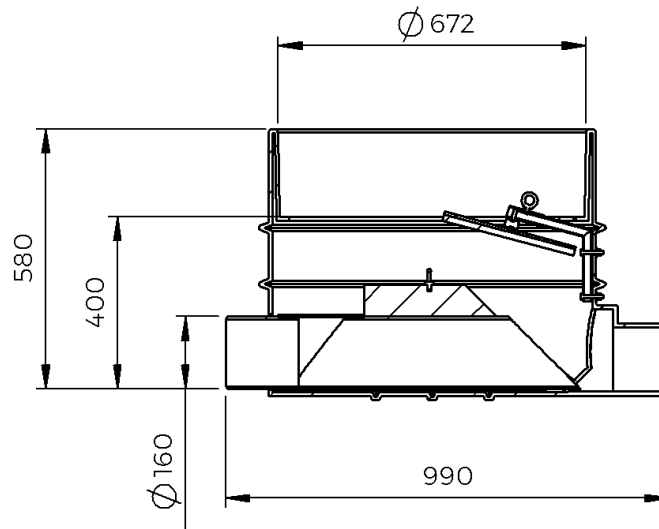

- *) +/- 15%
- Values measured from bottom of pipe.
- Tests performed at room temperature (16-20°C). No pipe connected downstream